

Surgical Implant Kits and Tools

Elevate your surgical procedures with our high-quality implant kits and surgical tools. Designed for precision and reliability, our products ensure optimal outcomes for both clinicians and patients.

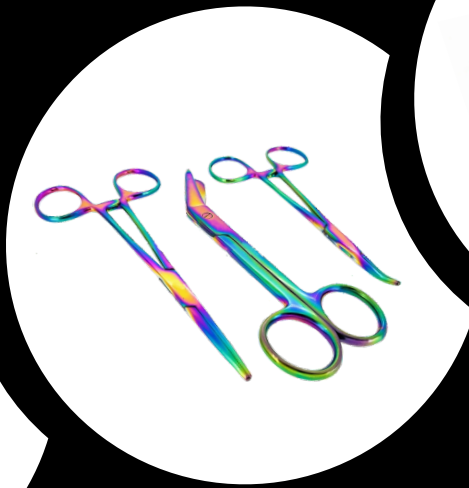
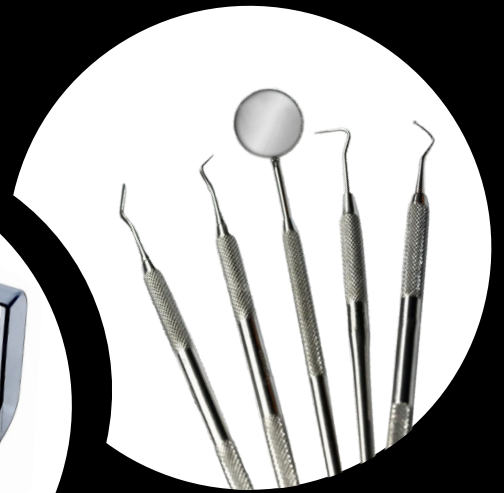

Index

01	DENTAL IMPLANTS KITS	01-13
02	DENTAL IMPLANTS KITS & CASSETTE	14
03	IMPLANTOLOGY	15-18
04	SURGERY BASIC & SOFT TISSUE SURGERY SETS	19
05	IMPLANTOLOGY	20-21

Introduction

Med Instruments is a leading manufacturer and supplier of dental implant kits and tools. We offer a wide range of high-quality products that are designed to meet the needs of dental professionals worldwide. Our products are made from the finest materials and are rigorously tested to ensure their quality and durability. We take pride in our commitment to providing our customers with the best possible service and support. Whether you're looking for dental implant kits, surgical instruments, or other dental tools, **Med Instrument** has everything you need to get the job done right.



Surgical Implant Kits and Tools

we offer warranties and guarantees for our products. Our products are made from the finest materials and are rigorously tested to ensure their quality and durability. We take pride in our commitment to providing our customers with the best possible service and support. If you have any issues with our products, please don't hesitate to contact us. We'll be happy to help you resolve any issues you may have.



“Cutting edge technology and superior quality”

Making products that dentists can Trust and are satisfied with:
This is our mission at Med Instrument

Dental Universal Implant Prosthetic Kit Torque Wrench Screw Driver Remover + Box

Features:

- Torque Wrench: 15-70N.cm
- Drivers 0.9 (Long + Short)
- Drivers 1.0 (Long + Short)
- Drivers 1.2 (Long + Short)
- Drivers 1.25 (Long + Short)
- Drivers 1.27 (Long + Short)
- Drivers 1.4 (Long + Short)
- Drivers NOB (Long + Short)
- Drivers R165 (Long + Short)



Top Quality

- Material : Stainless Steel
- Box can be sterilized!!! 135°C Autoclavable
- Don't disinfect at 135° for more than 5 minutes!!!



Dental Implant Tools

Dental Implant Torque Wrench
All-purpose tool box for planting and repairing









Bone Expander kit Dental sinus Lift With Saw Disks Dental Implant Instruments

KIT INCLUDES:

- 1) Expander Screws
 - 1.6 / 2.6mm
 - 1.9 / 3.0mm
 - 2.1 / 3.4mm
 - 2.6 / 3.8mm
 - 2.9 / 4.3mm
- 2) Saw Disks
 - 7.0mm
 - 10.0mm
- 3) Pilot Drill 1.6mm
- 4) Hand piece Adapter
- 5) Ratchet Extender
- 6) Hand Driver
- 7) Ratchet Wrench 4.0mm



**MDI-P510
Expander Kit**



MDI-P520
Dental Universal Implant Prosthetic Kit Torque Wrench Screw Drivers Remover + Box



**MDI-P530
Bone Expanders**



**MDI-P550
Implant Drills**



MDI-P540

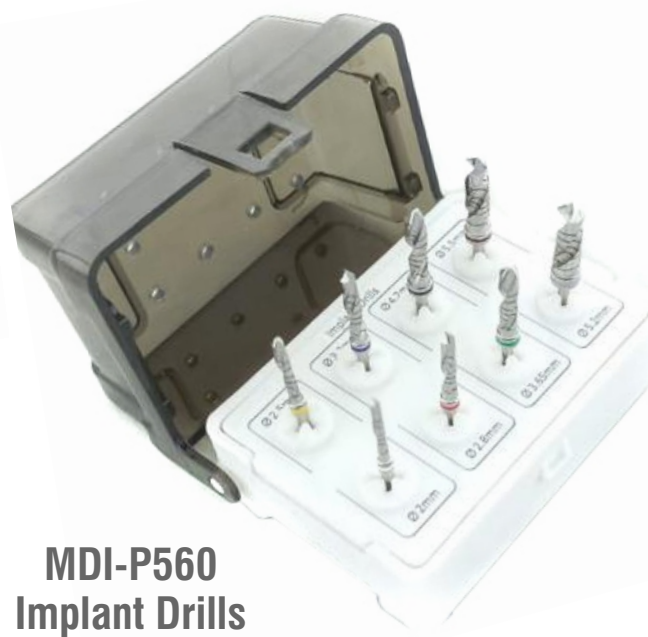

**MDI-P560
Implant Drills**



MDI-P580
Tissue Punch Kit



MDI-P570



MDI-P590
Lateral Approach
Sinus Lift Drills



MDI-P600
Saw Disks



MDI-S1000
Universal Densah Bur Kit



MDI-S1010
Osseodensification Burs Kit



**MDI-S1020
Saw Disk Kit**

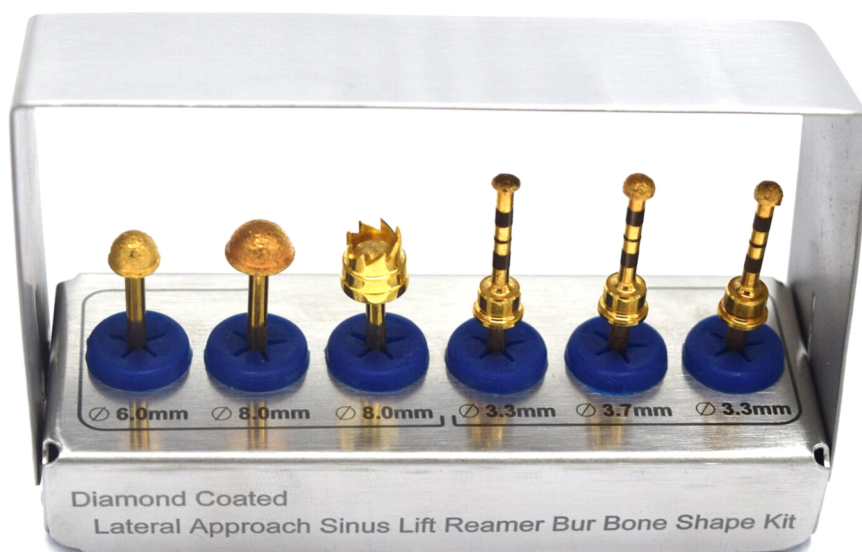

**MDI-S1030
Diamond Coated Lateral Approach
Sinus Lift Reamer Bur Bone Shape Kit**



MDI-S1040
Tissue Punch Kit



MDI-S1070



MDI-S1050
Bone Collector Kit



MDI-S1080



MDI-S1060
Osseodensification
Burs Kit



MDI-S1090



**MDI-S1100
 Surgical Drill Kit**

Set of 50 Pieces Universal Dental Implant Kit Bone Expander Conical Drills Kit

Kit Includes:

16pcs Conical Drills with Stoppers

- 1.8mm / 2.2mm - S1
- 1.8mm / 2.2mm - S3
- 1.8mm / 2.2mm - S5
- 1.8mm / 2.2mm - S7
- 2.2mm / 2.7mm - S1
- 2.2mm / 2.7mm - S3
- 2.2mm / 2.7mm - S5
- 2.2mm / 2.7mm - S7
- 2.3mm / 3.3mm - S1
- 2.3mm / 3.3mm - S3
- 2.3mm / 3.3mm - S5
- 2.3mm / 3.3mm - S7
- 2.8mm / 4.5mm - S1
- 2.8mm / 4.5mm - S3
- 2.8mm / 4.5mm - S5
- 2.8mm / 4.5mm - S7
- S = Stopper Length

- Compression Screw 2.8 / 4.0mm
- Compression Screw 4.0mm
- Driver 2.5mm
- Compression Screw 2.0 / 2.8mm
- Compression Screw 2.8 / 3.4mm
- Tissue Punch 4.5mm
- Tissue Punch 5.8mm
- Pilot Drill 2.0mm
- Drill Extender
- Ratchet Driver 2.5mm
- Hand Driver 2.5mm
- Torque Wrench 6.35mm (10-40Ncm)
- Depth Gauge
- Sterilization Cassette / Box

Bone Expander Screws

- 1.6mm / 2.6mm
- 1.9mm / 3.0mm
- 2.9mm / 3.4mm
- 2.3mm / 3.8mm
- 2.9mm / 4.3mm

Titanium Coated Drills

- Drill Bit 2.0mm L 18.50
- Drill Bit 2.8mm L 18.50
- Drill Bit 3.65mm L 18.50
- Drill Bit 4.2mm L 18.50
- Drill Bit 4.5mm L 18.50
- Drill Bit 4.8mm L 18.50
- Drill Bit 5.2mm L 18.50

8pcs Trephine Drills

- Int: 9.0mm, Ext: 10.0mm
- Int: 2.0mm, Ext: 3.0mm
- Int: 3.0mm, Ext: 4.0mm
- Int: 4.0mm, Ext: 5.0mm
- Int: 5.0mm, Ext: 6.0mm
- Int: 6.0mm, Ext: 7.0mm
- Int: 7.0mm, Ext: 8.0mm
- Int: 8.0mm, Ext: 9.0mm

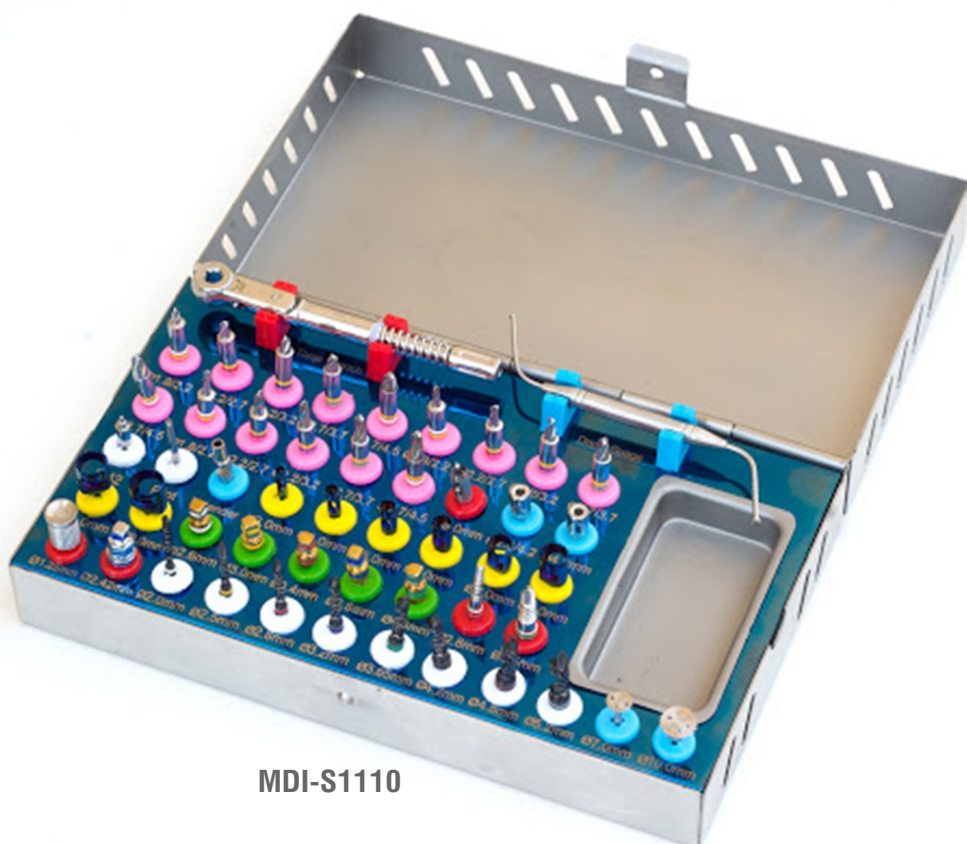

MDI-S1110



**MDI-S1120
Wrench Drill Kits**



**MDI-S1130
Titanium Coated Drills**

Dental Bone Expander Kit Sinus Lift Implant New Surgical Instruments

- Expander Screws
- 1.6 / 2.6mm
- 1.9 / 3.0mm
- 2.1 / 3.4mm
- 2.6 / 3.8mm
- 2.9 / 4.3mm
- With Laser Depth Markings on 8mm, 10mm & 11.5mm.
- Saw Disks
- 7.0mm
- 10 mm
- Ratchet Wrench 4.0mm
- Ratchet Extender
- Pilot Drill 1.6mm
- Latch Adapter
- Manual Knop
- Sterilization Cassette / Box



MDI-S1140

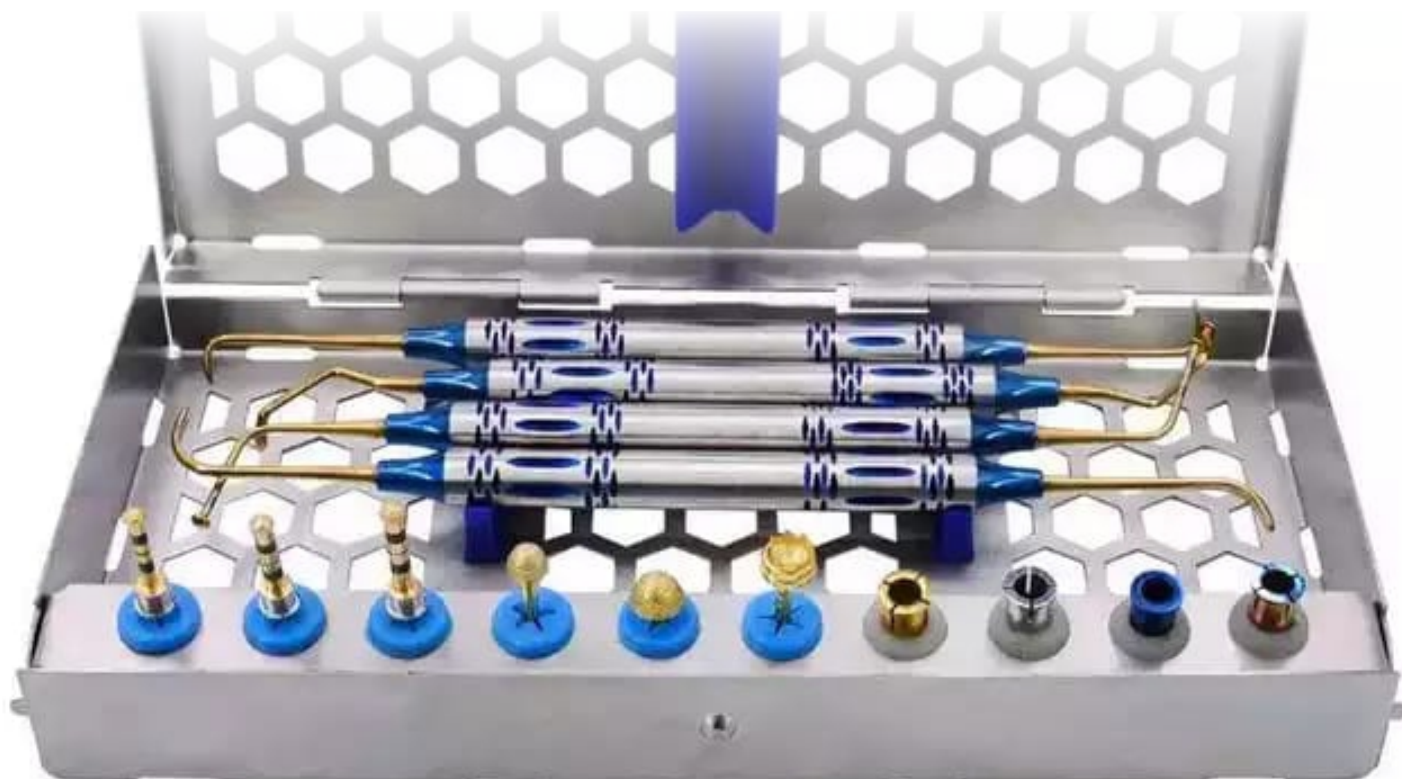

MDI-S1150

Dental Implant Advanced Sinus Kit Lift Dask Drills Stoppers Elevation Instrument

Bone Mill and Bone Crusher



MDI-201
Bone crusher for large
bone pieces, inox



MDI-202
Bone mill forceps
175 mm



Milling part in pure
titanium

Bone Management Kit



MDI-203
Bone Management Kit
Contains: 1 each of
Tray Titanium
Bone scoop / plugger
Bone scraper
Surgical aspirator
Filter
Bone injector Ø 3.5mm
Bone injector Ø 2.5mm
Gammafi x tray Doi

Bone Injectors and Collectors



MDI-251
Ø 2.5 mm
150 mm

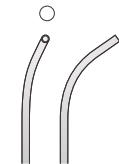

MDI-252
Ø 3.5 mm
150 mm

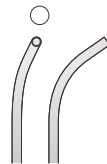

MDI-253
Ø 4.4 mm
150 mm

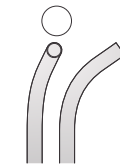

MDI-254
Ø 7.0 mm
150 mm



MDI-255
Ø 2.5 mm
150 mm

MODEL WITH CONE

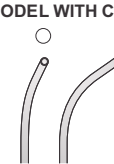

MDI-256
Ø 3.5 mm
150 mm

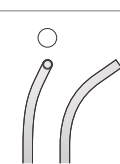

MDI-257
Ø 4.4 mm
150 mm



MDI-258
Medesy bone collector
155 mm



MDI-259
Mixing and bone collector
spatula
180 mm



MDI-260
Bone scoop Medesy BS1
Ø 5 mm
155 mm



MDI-261
Bone injector
Ø 3.5 mm
155 mm



MDI-262
Well in stainless steel
Ø 30 mm
25 mm



MDI-263
Mini tray titanium
60 x 50 x 15 mm

Bone Aspirators



MDI-301
Ø 7 mm
185 mm



MDI-302
Spare Filter
for 1331/1
Autoclavable



MDI-303
Ø 12 mm
185 mm



MDI-304
Spare Filter
for 1331/2
Autoclavable



MDI-305
Ø 12 mm
270 mm



MDI-306
Inox
for 1331/1
Autoclavable



MDI-307
Aspirator Kit
Contains: 1 each of
Bone scoop / plugger
Surgical aspirator Ø 7mm
Filter
Surgical aspirator Ø 12mm
Filter
Gammafi x tray Un

Bone Pluggers and Compactors

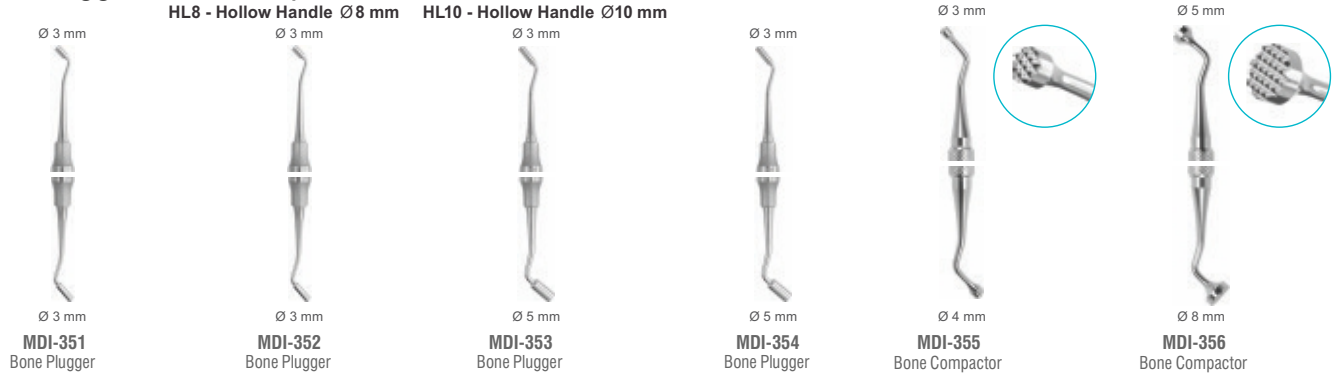

Sinus Lift Instruments

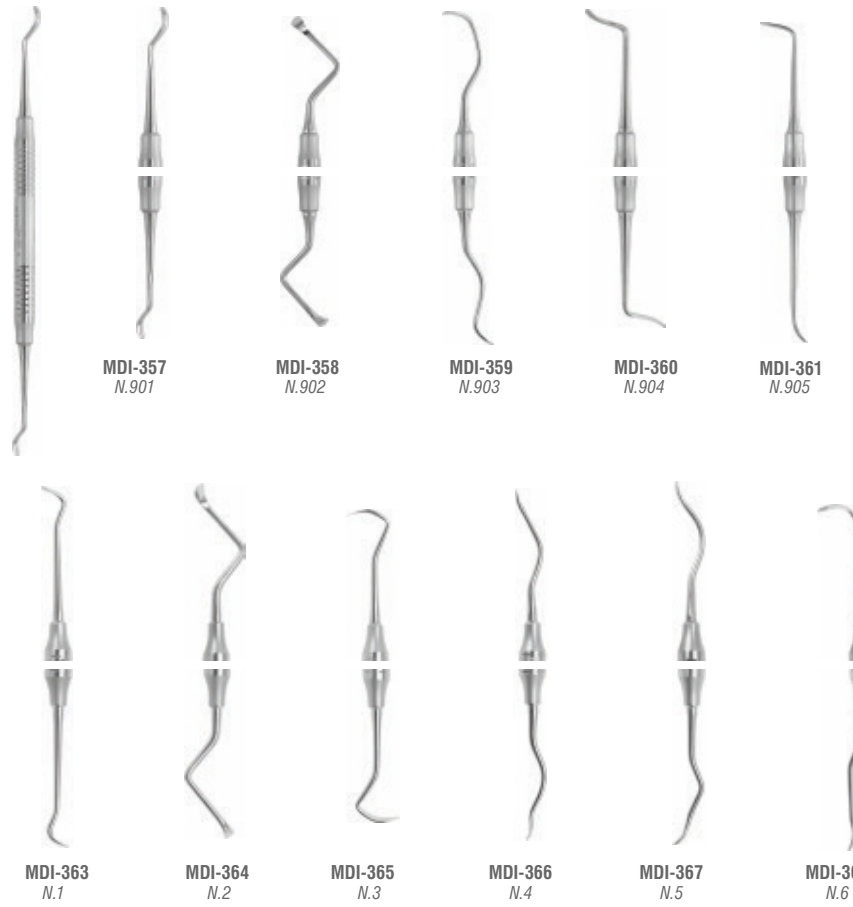

MDI-362 Sinus Lift Kit
Contains: 1 each of
Sinus lift N.901
Sinus lift N.902
Sinus lift N.903
Sinus lift N.904
Sinus lift N.905
Tray



Chisels and Mallets

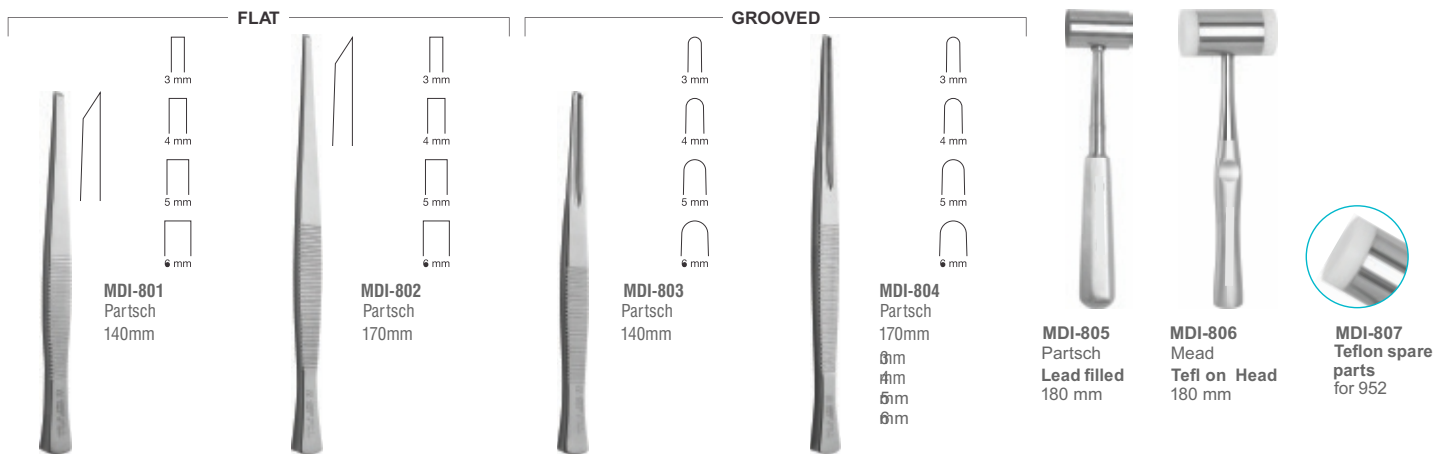



Chisels and Mallets

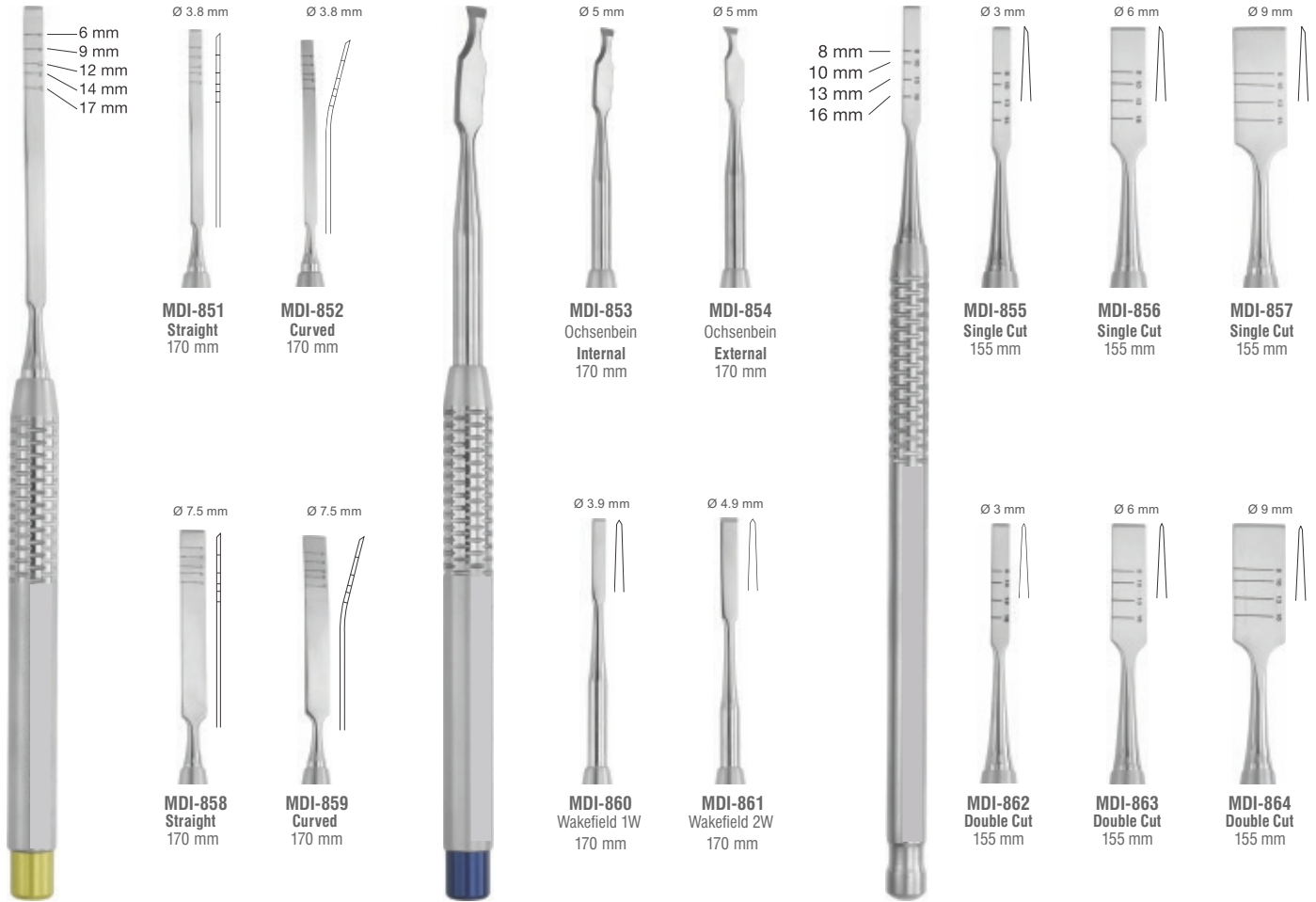

Tweezers for Pins and Abutments

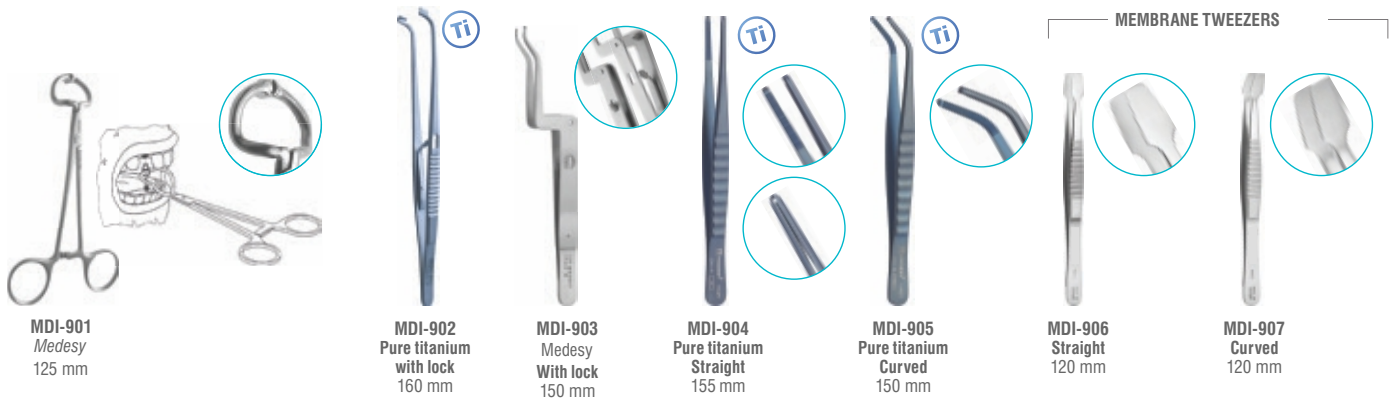

Calipers

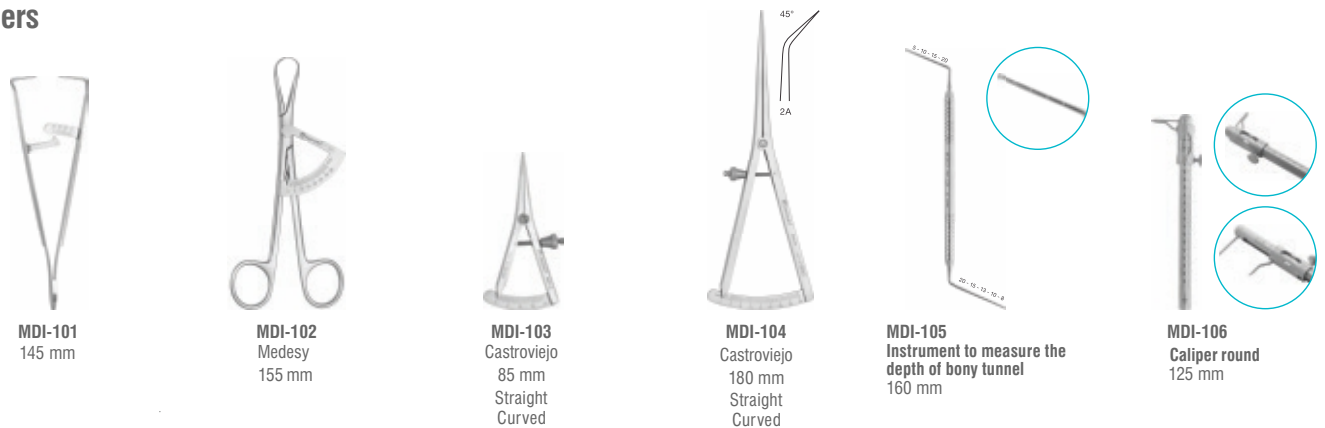

Bone Graft Holding Pliers

For placing screws on bone blocks



MDI-051
Straight
220 mm



MDI-052
Curved
220 mm



MDI-053
Curved
200 mm

Implantology

Implantology Kits

MDI-1200

Bone Splitting Kit

Contains: 1 each of
Sinus lift N.901
Sinus lift N.902
Sinus lift N.905 Titanium
Chisel 3 mm
Chisel 6 mm
Chisel 9 mm
Bone rongeur Micro Friedman
Chisel Wakefi eld 1W
Chisel Wakefi eld 2W
Hammer Medesy
Gammaf x tray Quatri



MDI-1201

Bone Split and Sinus Lift

Contains: 1 each of
Sinus lift N.902
Sinus lift N.905
Sinus lift N.7
Chisel 6 mm
Chisel 9 mm
Chisel 1R
Chisel 2A
Chisel 3R
Chisel 4A



MDI-1202

Osteotome & Sinus Elevation Kit

Contains: 1 each of
Osteotome concave Ø 2.7 mm
Osteotome concave Ø 3.2 mm
Osteotome concave Ø 3.7 mm
Osteotome concave Ø 4.2 mm
Osteotome concave Ø 5.0 mm
Osteotome concave Ø 2.7 mm bayonet
Osteotome concave Ø 3.2 mm bayonet
Osteotome concave Ø 3.7 mm bayonet
Osteotome concave Ø 4.2 mm bayonet
Osteotome concave Ø 5.0 mm bayonet
Bone injector Ø 4.4 mm
Bone injector Ø 3.5 mm
Hammer Mead
Gammaf x tray Quatri

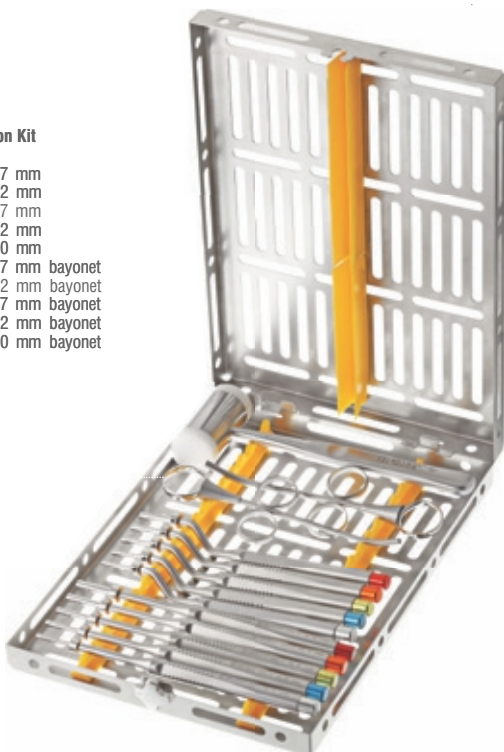

MDI-1203

Sinus Advanced Kit

Contains: 1 each of
Sinus lift N.1
Sinus lift N.2
Sinus lift N.7
Osteotome convex Ø 3.2mm
Osteotome convex Ø 3.7mm
Osteotome convex Ø 3.2mm bayonet
Osteotome convex Ø 3.7mm bayonet
Osteotome concave Ø 3.2mm
Osteotome concave Ø 3.7mm
Osteotome concave Ø 3.2mm bayonet
Osteotome concave Ø 3.7mm bayonet
Bone curette Lucas N.85
Bone curette Lucas N.86
Bone curette Lucas N.87
Hammer Mead
Gammaf x tray Quatri

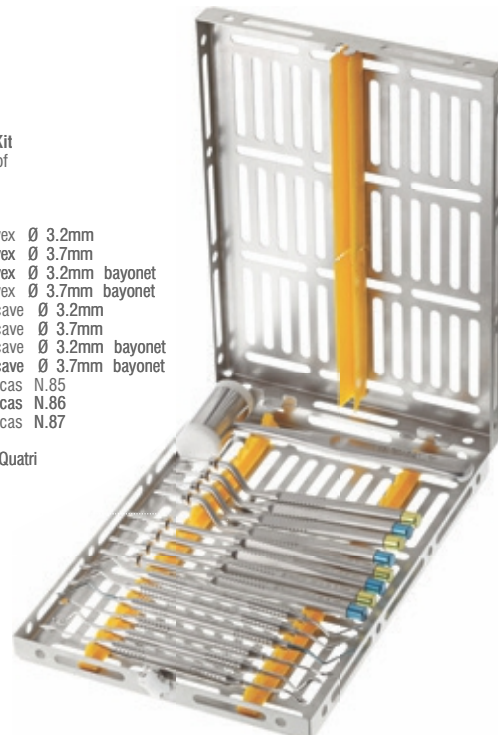



MDI-1204
Suture Removal Set
Contains: 1 each of
Tweezer Perry
Tweezer Meriam
Scissor Spencer
Mirror N. 5 with Handle
Explorer Double
Gammafi x Tray Tre



MDI-1205
Soft Tissue Surgery Set
Contains: 1 each of
Tweezer De Bakey Mini
Tweezer Round OY
Needle Holder Castrobiejo
Scissors Castroviejo
Scalpel Handle Micro Blades
Micro Blades Box (Not shown)
Periosteal Medesy
Periosteal Molt
Gammafi x Tray Tre



MDI-1206
Surgery Basic Set
Contains: 1 each of
Tweezer Round
Needle Holder Crile-Wood
Needle Holder Mathieu
Scissor Iris Black Sharp
Scissor Goldman-Fox
Scalpel Handle Bard Parker
Scalpel Handle Adjustable
Bone Rongeur Micro Fieldman
Probe CP15
Periosteal Goldman-Fox
Periosteal Prichard
Periosteal Molt N. 9
Periosteal Misch N. 2
Gammafi x Tray Cinc

Essential instruments needed for implant surgery in one kit.



MDI-1301
 Stainless Steel
 Cassette



MDI-1305
 Explorer #05N



MDI-1306
 Serrated Lucas Surgical Bone Curette #710S



MDI-1302
 Seldin Periosteal Elevator #23D



MDI-1307
 Gerald Tissue Forceps



MDI-1303
 Molt #9 Periosteal Elevator #715

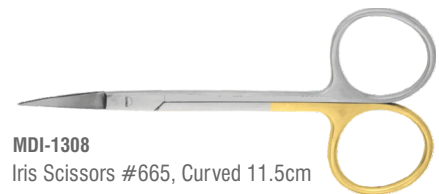

MDI-1308
 Iris Scissors #665, Curved 11.5cm



MDI-1304
 Molt Curette #24



MDI-1309
 Crile-Wood Needle Holder #690

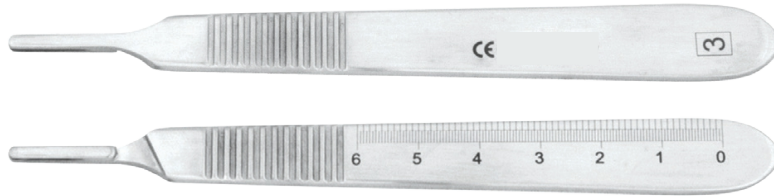

MDI-1310
Scalpel Handle #605



MDI-1311
Mirror Handle #493C



MDI-1312
Mirror #5



MDI-1313
Cotton Pliers #561



MDI-1314
Aspirating Syringe, 1.8MI



Med Instruments Medical Equipment Trading LLC

Dubai Investment park 1 building name: falcon house
second floor: section 204 and 203 second floor
Czar business center

Tel:00971 55 10 2525 1

E-mail: info@medinstrument.net

Web: www.medinstrument.net